

**CILINDER
ZYLINDER
CYLINDER**

AIRSGAL

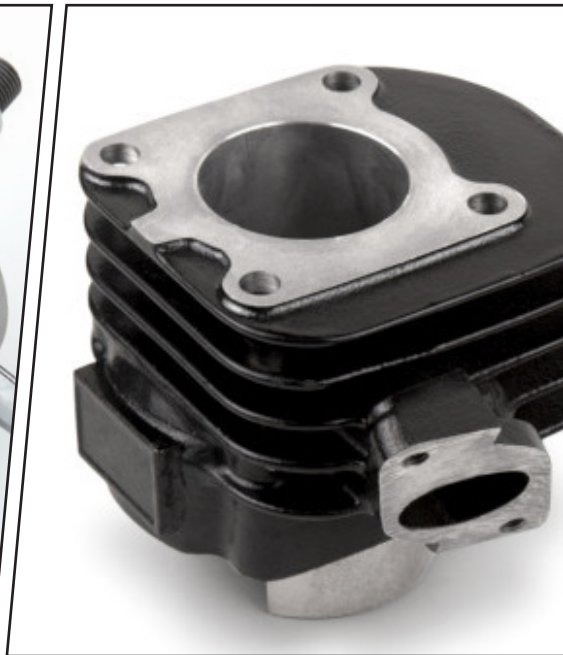
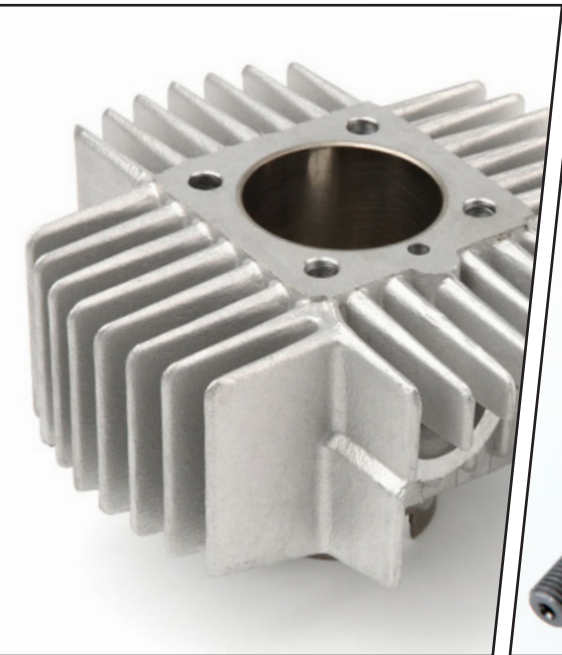

2017 4

CILINDER ZYLINDER CYLINDER

AIRSGL









2013 CILINDER /ZYLINDER APRILIA RV 43.50mm

€ 99,90

REFERENCE

APRILIA RV.

APRILIA

∅ mm	Stroke / Carrera	cm ³	N° RINGS						
43,5	60	2		2013			2014	110306435	2063



02350439 CILINDER /ZYLINDER CHINA 4T GY6 50cc 39mm







€ 79,90

 Available
spring 2017

REFERENCE

KEEWAY Flory 50,
KYMCO Agility 50, NMC 50, Filly 50, Vitality 50, People 4T, Super 8.
PEUGEOT V-click.
RIEJU Toreo, Pacific.

CHINA 4T

∅ mm	Stroke / Carrera	cm ³	N° RINGS						
39,0				02350439			06350439	11350439	14350439

CILINDER ZYLINDER CYLINDER

AIRSGAL



CHINA 139QMB 4T

88300 CILINDER /ZYLINDER CHINA 4T ALU 50.0mm

€ **94,90**

REFERENCE

ENGINE 139 QMb.
BOATIAN BT49QT-2, BT49QT-7, BT50QT-9, Ecobike.
KEEWAY Flory 50,
KYMCO Agility 50, NMC 50, Filly 50, Vitality 50, People 4T, Super 8.
PEUGEOT V-click.
RIEJU Toreo, Pacific.



50

Stroke /
Carrera

81,3

cm³

N° RINGS

3



88300



88301



88302



88303



CHINA 152QMI 125cc

88964 CILINDER /ZYLINDER CHINA 125 152QMI 57.4mm

€ **112,90**

REFERENCE

ENGINE 152 QMI.
BOATIAN BT125T, Rally.
KYMCO Agility, Agility 125, People 125, Movie 125, City 125, Like 125.
RIEJU Pacific.
TGB 303R 125, Delivery 125.



57,4

Stroke /
Carrera

149,5 cc

cm³

N° RINGS

3



88964



88970



113502574



88967

CILINDER ZYLINDER CYLINDER

AIRSGAL











88965 CILINDER /ZYLINDER CHINA 125 60.0mm

€ 119,90

REFERENCE

ENGINE 157QMJ
KYMCO People 150, Bet & Win.

CHINA 157QMJ 125cc

∅ mm	Stroke / Carrera cm ³	N° RINGS						
60	163,4	3		88965		88971	11350360	88968











88966 CILINDER /ZYLINDER CHINA 125 GY6 57.4mm

€ 112,90

REFERENCE

ENGINE GY6.
KEEWAY 125, Arn 125, Fact 125, Matrix 125.

CHINA 125 GY6

∅ mm	Stroke / Carrera cm ³	N° RINGS						
57,4	149,5 cc	3		88966		88972	113601574	88969

CILINDER ZYLINDER CYLINDER

AIRSGAL



87891 CILINDER /ZYLINDER CPI GTR 40.0 mm

€ **220,90**







87892 CILINDER /ZYLINDER CPI GTR 47.6 mm

€ **220,90**

REFERENCE

CPI GTR 50.

CPI GTR

∅ mm	Stroke / Carrera cm ³	N° RINGS						
40,0	49,2 cc	1	87891		04300540	87893	11024640	87898
47,6	69,7 cc	1	87892			87894	2158	87895



88584 CILINDER /ZYLINDER CPI SMX 40.0 mm

€ **205,90**







88974 CILINDER /ZYLINDER CPI SMX 50.0 mm

€ **248,90**

REFERENCE

CPI Supermoto, SMX, Supercross.

CPI SMX

∅ mm	Stroke / Carrera cm ³	N° RINGS						
40	49,2	1	88584			06300940	11024640	14300940
50	76,9	1	88974			06301150	87756	14301150

CILINDER ZYLINDER CYLINDER

AIRSGAL









- 86625 CILINDER /ZYLINDER CPI"03 E2 T6 40.0 mm **T6** € 130,90
- 86626 CILINDER /ZYLINDER CPI"03 E2 T6 47.6mm **T6** € 142,90

REFERENCE

CPI 2003 Euro 2, Popcorn, JP 50, Oliver City, Oliver Sport.

CPI '03 E2 T6

	∅ mm	Stroke / Carrera cm ³	N° RINGS						
T6	40,0	49,2 cc	2	86625		04300140	87151	11024640	87153
T6	47,6	69,5 cc	2	86626		89077	87156	2158	87154









- 88076 CILINDER /ZYLINDER CPI"04 E2 T6 40.0 mm **T6** € 130,90
- 88077 CILINDER /ZYLINDER CPI"04 E2 T6 47.6mm **T6** € 142,90

REFERENCE

CPI 2004 Euro 2, Popcorn, JP 50, Oliver City, Oliver Sport.
GENERIC XOR 50, Ideo 50.
KEEWAY Hurricane, Flash, F-act, Matrix.

CPI '04 E2 T6

	∅ mm	Stroke / Carrera cm ³	N° RINGS						
T6	40,0	49,2 cc	2	88076			06300340	11024640	14300340
T6	47,6	69,5 cc	2	88077			063004476	2158	143004476

CILINDER ZYLINDER CYLINDER

AIRSGL









2028 CILINDER /ZYLINDER DERBI MAHLE 39.9mm

€ 189,90

REFERENCE

DERBI Euro 2 (<2006).
GILERA GSM, Zulu.

DERBI E2

∅ mm	Stroke / Carrera	cm ³	N° RINGS						
39,9	50	2	2028					110832399	140832399



01089950 CILINDER /ZYLINDER DERBI E2 50.0mm







T6 € 379,90

**RACING
EXTREME**

REFERENCE

DERBI EURO2, DRD, GPR Racing, R Racer, Senda 50, SM Supermotard.
GILERA GSM, Zulu.

DERBI E2

∅ mm	Stroke / Carrera	cm ³	N° RINGS						
T6 50,0	40	78,5 cc	1	01089950		04089950	06089950		14089950

CILINDER ZYLINDER CYLINDER

AIRSGL



010810050 CILINDER /ZYLINDER DERBI GPR SENDA 50.0mm

€ 379,90





**RACING
EXTREME**

REFERENCE

ENGINE Piaggio.
DERBI Mod. 2006 Senda, SM, DRD, Pro SM, DRD Racing.
GILERA RCR, SMT.

DERBI GPR

	∅ mm	Stroke / Carrera	cm ³	N° RINGS						
T7	50,0	40	49,2 cc	1	010810050			060810050	87756	140810050



2117 CILINDER /ZYLINDER DERBI SENDA-R 39.9mm € 180,90

2121 CILINDER /ZYLINDER DERBI SENDA-R 48.0mm € 182,90







87754 CILINDER /ZYLINDER DERBI SENDA-R 50.0mm € 248,90



REFERENCE

DERBI DRD, GPR Racing, Senda 50, Sm supermotard.
GILERA GSM, Zulu.

DERBI SENDA OT

	∅ mm	Stroke / Carrera	cm ³	N° RINGS						
	39,9		50,0 cc	1	2117		86289	2118	2119	2120
	48,0		72,4 cc	1	2121		86290	2122	2123	2124
VERTEX	50,0		78,5 cc	1	87754			87755	87756	87757

CILINDER ZYLINDER CYLINDER

AIRSGAL

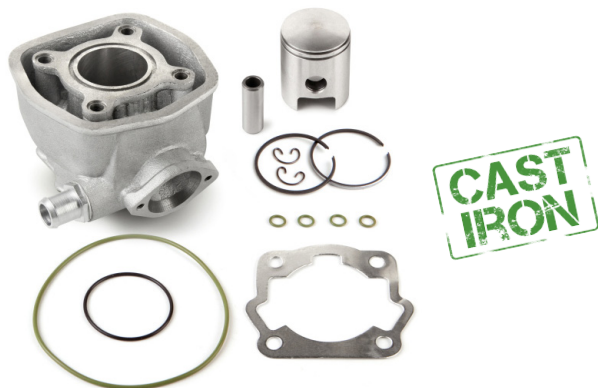







H010890399 CILINDER /ZYLINDER DERBI SENDA ot 39.9mm € **193,90**

REFERENCE

DERBI DRD, GPR Racing, R Racer, Senda 50.
GILERA GSM, Zulu

DERBI SENDA OT

∅ mm	Stroke / Carrera cm ³	N° RINGS						
39,9	40	50,0 cc	2	H010890399		H060890399	110808399	



87884 CILINDER /ZYLINDER SENDA"06 39.9mm € **182,90**

87954 CILINDER /ZYLINDER SENDA"06 48.0mm € **186,90**







87767 CILINDER /ZYLINDER SENDA"06 50.0mm € **260,90**

VERTEX
PARTS & SERVICE

REFERENCE

ENGINE Piaggio.
DERBI Mod. 2006 Senda, SM, DRD, Pro SM, DRD Racing.
GILERA RCR, SMT.

DERBI SENDA NT

∅ mm	Stroke / Carrera cm ³	N° RINGS						
39,9	50,0 cc	1	87884		040840399	87885	2119	87889
48,0	72,4 cc	1	87954		04084248	87886	2123	87890
50,0	78,5 cc	1	87767		04084350	87768	87756	87770

CILINDER ZYLINDER CYLINDER

AIRSGL









H010892399 CILINDER /ZYLINDER DERBI SENDA nt 39.9mm **€ 193,90**

REFERENCE

DERBI EURO 3.
ENGINE PIAGGIO.
GILERA RCR, SMT.

DERBI SENDA NT

∅ mm	Stroke / Carrera cm ³	N° RINGS						
39,9	40,0	50,0 cc	2	H010892399				



020808399 CILINDER /ZYLINDER DERBI VARIANT START 39.9mm **€ 97,90**







010810347 CILINDER /ZYLINDER DERBI VARIANT START 47.0mm **€ 169,90**



REFERENCE

DERBI Variant Start.

DERBI VARIANT

∅ mm	Stroke / Carrera cm ³	N° RINGS						
39,9	50,0 cc	1		020808399		060808399	110808399	140808399
47,0	69,4 cc	2	010810347		040810347	060810347	2038	140810347



CILINDER ZYLINDER CYLINDER

AIRSGAL









2020 CILINDER /ZYLINDER ETON VIPER 52.0mm

€ **216,90**

REFERENCE

EATON Viper, RXL 90, Predator AXL 90.
ARTIC CAT 90.
POLARIS Scrambler 90, Sportsman 90.

ETON VIPER

∅ mm	Stroke / Carrera	cm ³	N° RINGS						
52,0	89	1	2020						









87603 CILINDER /ZYLINDER HONDA DIO 46.0mm

€ **89,90**

REFERENCE

HONDA Dio 50, SP 50, SR 50, ST 50, ZX 50.

HONDA DIO

∅ mm	Stroke / Carrera	cm ³	N° RINGS						
46,0	69,4 cc	2	87603						

CILINDER ZYLINDER CYLINDER

AIRSGAL



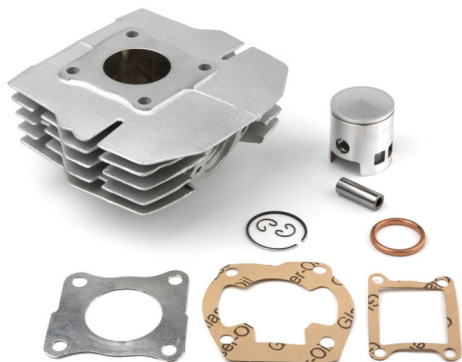



2025 CILINDER / ZYLINDER HONDA MB/MT 45.0mm € 94,90



REFERENCE

HONDA MB 50, MT 50.

HONDA MB/MT

∅ mm	Stroke / Carrera cm ³	N° RINGS						
45,0	65,7 cc	2		2025		2023	2080	14040845



020462524 CILINDER / ZYLINDER PANTHEON 125 4T 52.4mm € 149,90

02046358 CILINDER / ZYLINDER PANTHEON 125 4T 58.0mm € 149,90







REFERENCE

HONDA Pantheon 124 4T, SH 125, S-Wing, SH125 I, Dylan 125, PS 125, SH 125 Scoopy, SH 125 I.

KEEWAY Outlook (QJ153MJ-2) 125 4T.

MALAGUTI Blog (03) 125 4T LC.

HONDA PANTHEON 125

∅ mm	Stroke / Carrera cm ³	N° RINGS						
52,4	57,8	124,6 cc	3	020462524		060462524	110462524	140462524
58,0	57,8	152,7 cc	3	02046358				

CILINDER ZYLINDER CYLINDER

AIRSGL









02046458 CILINDER /ZYLINDER PANTHEON 150 4T LC 58.0mm **€ 149,90**

REFERENCE

HONDA 150 4T, Pantheon 150 4T LC, S-Wing, SH150 I, Dylan 150 4T, PS 150 4T LC, SH Scoopy 150 4T.
KEEWAY Outlook (QJ158MJ) 150 4T.

HONDA PANTHEON 150

∅ mm	Stroke / Carrera cm ³	N° RINGS						
58,0	57,8	152,7	3	02046458		06046458	11046458	14046458









020480524 CILINDER /ZYLINDER HONDA PCX 125 <2011 52.4mm **€ 171,90**

 Available
Spring 2017

REFERENCE

HONDA PCX125 ≤ 2011.

HONDA PCX <2011

∅ mm	Stroke / Carrera cm ³	N° RINGS						
52,4	125 cc	3		020480524		060480524		140480524

CILINDER ZYLINDER CYLINDER

AIRSGAL



020481524

CILINDER /ZYLINDER HONDA PCX 125 >2012 52.4mm







€ 171,90

Available
Spring 2017

REFERENCE

HONDA PCX 125 ≥ 2012.
HONDA SH 125 ≥ 2013.

HONDA PCX >2012

∅ mm	Stroke / Carrera cm ³	N° RINGS						
52,4	125 cc	3		020481524		060481524		140481524



2047 CILINDER /ZYLINDER HONDA SCOOPIY/LEAD 40.0mm

€ 79,90







2048 CILINDER /ZYLINDER HONDA SCOOPIY/LEAD 48.0mm

€ 79,90

REFERENCE

HONDA Lead 50, SH 50 (≤ 96).

HONDA SCOOPIY/LEAD

∅ mm	Stroke / Carrera cm ³	N° RINGS						
40,0	49,9 cc	2		2047		2053	2101	14041840
46,0	65,3 cc	2		2048		2054	11041946	14041946

CILINDER ZYLINDER CYLINDER

AIRSGAL



02044539









CILINDER /ZYLINDER HONDA SFX/X8R 39.0mm

€ 89,90

REFERENCE

HONDA Bali 50, SGX Sky 50, SXR 50, SFX 50, SH 50, X8R 50.

HONDA SFX/X8R

∅ mm	Stroke / Carrera cm ³	N° RINGS						
39,0	49,4 cc	2		02044539		06044539	11044539	14044539



2049 CILINDER /ZYLINDER HONDA VISION 41.0mm

€ 79,90











2050 CILINDER /ZYLINDER HONDA VISION 46.0mm

€ 74,90

REFERENCE

HONDA Vision NE 50.
PEUGEOT Rapido, ST 50.

HONDA VISION

∅ mm	Stroke / Carrera cm ³	N° RINGS						
41,0	49,4 cc	2		2049		2055	2103	14042041
46,0	62,1 cc	2		2050		2056	11041946	14042146

CILINDER ZYLINDER CYLINDER

AIRSGAL













2051 CILINDER /ZYLINDER HONDA WALLAROO/PK 40.0mm € **69,90**

2052 CILINDER /ZYLINDER HONDA WALLAROO/PK 46.0mm € **69,90**

REFERENCE

HONDA 150 4T, Phanteon 150 4T LC, S-Wing, SH150 I, Dylan 150 4T, PS 150 4T LC, SH Scoopy 150 4T.
KEEWAY Outlook (QJ158MJ) 150 4T.

HONDA WALLAROO

∅ mm	Stroke / Carrera cm³	N° RINGS						
40,0	49,3	1		2051		2171	11024640	14042240
46,0	65,3	2		2052		85243	11041946	85245

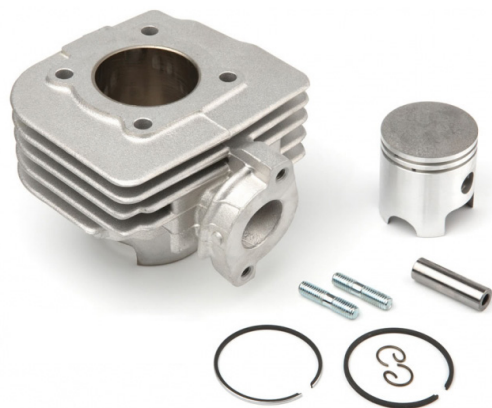











87545 CILINDER /ZYLINDER HYOSUNG RALLY SF50 41.0mm € **87,90**

87549 CILINDER /ZYLINDER HYOSUNG RALLY SF50 46.0mm € **89,90**

REFERENCE

HYOSUNG Prima, Rally.

HYOSUNG RALLY

∅ mm	Stroke / Carrera cm³	N° RINGS						
41,0	49,2 cc	2		87545		2097	2103	87548
46,0	62,0 cc	1		87549		87550	88072	87552

CILINDER ZYLINDER CYLINDER

AIRSGAL



2087 CILINDER /ZYLINDER KYMCO DJ50Y 50cc 39.0mm

€ **81,90**







2088 CILINDER /ZYLINDER KYMCO DJ50Y 50cc 46.0mm

€ **74,90**

REFERENCE

KYMCO BJW, Curio 50 CX, Curio CX Sup., DJR, KB 50, R 12 Scout ZX, Sniper.

KYMCO DJ

∅ mm	Stroke / Carrera cm ³	N° RINGS						
39,0	49,9 cc	2		2087		2093	2099	87109
46,0	69,4 cc	2		2088		2094	11041946	14160246



86331 CILINDER /ZYLINDER KYMCO SUPER 9 LC 39.0mm

€ **201,20**







86332 CILINDER /ZYLINDER KYMCO SUPER 9 LC 47.6mm

€ **203,90**

REFERENCE

KYMCO Bet&Win 50, Dink 50 LC, Super 9 50.

KYMCO SUPER 9

∅ mm	Stroke / Carrera cm ³	N° RINGS						
39,0	49,5 cc	2	86331		86335	86336	11044539	86338
46,0	73,8 cc	1	86332			86339	2158	86341

CILINDER ZYLINDER CYLINDER

AIRSGAL









87125 CILINDER /ZYLINDER KYMCO TOPBOY/DINK AC 39.0mm € **92,90**

2166 CILINDER /ZYLINDER KYMCO TOPBOY/DINK AC 47.6mm € **99,90**

REFERENCE

KYMCO Dink 50, Top Boy 50, Vitality 2T.

KYMCO TOPBOY

∅ mm	Stroke / Carrera cm ³	N° RINGS						
39,0	49,5	2		87125		87126	11044539	87128
47,4	73,8	1		2166		5595	2158	88013









02140639 CILINDER /ZYLINDER MBK AV-51/AV-10 39.0mm € **67,90**

02144847 CILINDER /ZYLINDER MBK AV-51/AV-10 T6 47.0mm € **91,40**
T6

REFERENCE

MBK AV-10, AV-51.

MBK AV-51/AV-10

∅ mm	Stroke / Carrera cm ³	N° RINGS						
39,0	49,9 cc	2		02140639		06140639	11140139	
T6 47,0	72,5 cc	1		02144847				

CILINDER ZYLINDER CYLINDER

AIRSGAL



MBK AV-87/AV-7

02140239

CILINDER /ZYLINDER MBK AV-87/AV-7 39.0mm

€ 67,90







02140345

CILINDER /ZYLINDER MBK AV-87/AV-7 45.0mm

€ 67,90

REFERENCE

MBK AV-7, AV-87.

∅ mm	Stroke / Carrera cm ³	N° RINGS						
39,0	49,9 cc	2		02140239		06140239	11140139	
45,0	66,5cc	2		02140345			2080	14140345



MBK AV-88

02140139 CILINDER /ZYLINDER MBK AV-88/AV-7 39.0mm







€ 67,90

88973 CILINDER /ZYLINDER MBK AV-88 47.0mm

€ 73,90

REFERENCE

MBK Carre AV88.

∅ mm	Stroke / Carrera cm ³	N° RINGS						
39,0	49,9 cc	2		02140139		06140139	11140139	
47,0	72,5 cc	2		88973				14140847

CILINDER ZYLINDER CYLINDER

AIRSGAL

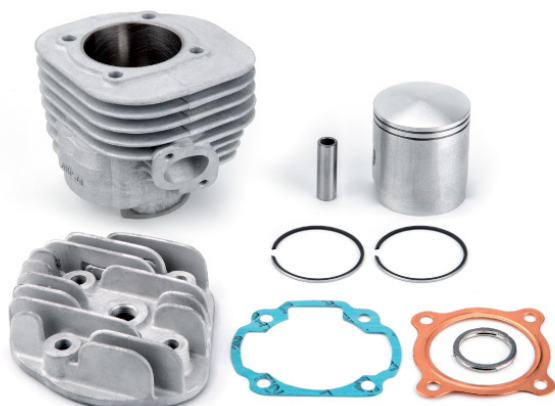







01126556 CILINDER /ZYLINDER MINARELLI 100cc 56.0mm **€ 176,90**

REFERENCE

APRILIA Scarabeo 100.
BENELI K2 100.
ITALJET Millenium 100.
MBK Booster 100, Nitro 100, Oveto 100.
YAMAHA Bw's 100, Aerox 100, Neo's 100.

MINARELLI 100cc

∅ mm	Stroke / Carrera cm ³	N° RINGS						
56,0	117,2	2	01126556			06126556	11126556	14126556









01139150 CILINDER /ZYLINDER MINARELLI AM345/6 50.0mm **€ 379,90**

**RACING
EXTREME**

REFERENCE

APRILIA Alle 50, Extrema, Red rose, RS 50, RX 50.
MBK X Limit, X Power.
MINARELLI AM 345/6, AM 6 EU1.
MOTORHISPANIA Furia 50, Racing RX 50, Supermotard.
PEUGEOT Supermotard, Trail, XP6, XR6.
RIEJU MRK, RS1, RR6 50, SMX.
YAMAHA DT 50 Supermotard, Thunderkit, TZR 50.

MINARELLI AM345/6







∅ mm	Stroke / Carrera cm ³	N° RINGS						
40,3	49,0 cc	2	01139150		04139150	06139150		14139150

CILINDER ZYLINDER CYLINDER

AIRSGAL



MINARELLI AM6

∅ mm	Stroke / Carrera cm ³	N° RINGS						
40,3	49,0 cc	2	2109		86287	2110	2111	2112
48,0	70,5 cc	1	2113		86288	2114	2123	2116
50,0	76,6 cc	1	87751			87752	87756	87759

2109 CILINDER /ZYLINDER MINARELLI AM6 40.3mm € 207,90

2113 CILINDER /ZYLINDER MINARELLI AM6 48.0mm € 206,90

87751 CILINDER /ZYLINDER MINARELLI AM6 50.0mm € 248,90









REFERENCE

APRILIA Alle 50, Extrema, Red Rose, RS 50, RX 50
 MBK X Limit, X Power.
 MINARELLI AM 345/6, AM 6 EU1
 MOTORHISPANIA Furia 50, Racing RX 50, Supermotard
 PEUGEOT Supermotard, Trail, XP6 XR6.
 RIEJU MRK, RS1, RR6 50, SMX
 SHERCO HRD Enduro, Supermotard
 YAMAHA DT 50 Supermotard, Thunderkit, TZR 50.



MINARELLI HORIZONTAL AC

∅ mm	Stroke / Carrera cm ³	N° RINGS						
40,0	49,2 cc	2	2032		86298	2034	2072	88861
46,0	65,0cc	2	2033		86300	2035	11041946	14131046
T6 40,0	49,2 cc	2	5266		86299	5271	11024640	5281
T6 47,6	69,7cc	2	5267		86301	5272	2158	5282

2032 CILINDER /ZYLINDER MINARELLI HORZ AC 40.0mm € 81,90

2033 CILINDER /ZYLINDER MINARELLI HORZ AC 46.0mm € 74,90

5266 CILINDER /ZYLINDER MINARELLI HORZ AC 40.0mm T6 € 102,90

5267 CILINDER /ZYLINDER MINARELLI HORZ AC 47.6mm T6 € 108,90

REFERENCE

APRILIA Gulliver, Rally, Scarabeo, Sonic, SR94, SR www.
 BENELLI 491 GT, K2 air, Namur, Pepe.
 BETA Ark, Chrono, Tempo, Quadra.
 MALAGUTI Centro, Ciak, F10, F12, Phantom 50, Yesterday.
 MINARELLI CY50.
 YAMAHA Axis, Breeze, Jog 50, Jag Z, Neos, Why, Zest.

CILINDER ZYLINDER CYLINDER

AIRSGAL



MINARELLI HORIZONTALAAL LC

2156 CILINDER / ZYLINDER MINARELLI LC 40.0mm







€ **197,90**

2155 CILINDER / ZYLINDER MINARELLI LC 47.6mm

€ **206,90**

REFERENCE

APRILIA Area, Gulliver, Ralli LC, Sonic, SR 50, Stealth LC.
 BENELLI 491 Sport Racing, K2 LC.
 BETA Ark LC, Eikon 50.
 ITALJET Dragster.
 MALAGUTI F12, F15, Firefox, Phantom LC.
 MBK Nitro 50.
 RIEJU First 50 LC.
 YAMAHA Aerox 50.

∅ mm	Stroke / Carrera cm³	N° RINGS						
40,0	49,2 cc	1	2156		86291	2168	2072	2175
47,6	69,7 cc	1	2155		86292	2157	2158	2159



MINARELLI LC39

01073450 CILINDER / ZYLINDER MINARELLI HORIZONTALAAL LC39 50s

€ **349,90**

RACING EXTREME







Uitsluitend te monteren met:
 Nür montage möglich mit:

***KRUKAS/KURBELWELLE**
 art. 31073450



REFERENCE

APRILIA Area, Gulliver, Ralli LC, Sonic, SR 50, Stealth LC.
 BENELLI 491 Sport Racing, K2 LC.
 BETA Ark LC, Eikon 50.
 ITALJET Dragster.
 MALAGUTI F12, F15, Firefox, Phantom LC.
 MBK Nitro 50.
 RIEJU First 50 LC.
 YAMAHA Aerox 50.

Pin / Bul.	∅ mm	Stroke / Carrera cm³	N° RINGS						
* 12mm	50,0	39,2	77,1	1	01073450	04073450	06073450	87756	14073450

CILINDER ZYLINDER CYLINDER

AIRSGAL









MINARELLI VERTICAAAL

2070	CILINDER /ZYLINDER MINARELLI VERT 40.0mm	€ 74,90
2073	CILINDER /ZYLINDER MINARELLI VERT 46.0mm	€ 74,90
5268	CILINDER /ZYLINDER MINARELLI VERT 40.0mm T6	€ 102,90
5269	CILINDER /ZYLINDER MINARELLI VERT 47.6mm T6	€ 108,90

REFERENCE

APRILIA Amico, Business, Gludman, LK, LX, Sport, SR.
ITALJET Ascot, Astra, Bazoka, Pista, Reporter.
MBK Booster, Rocket, Sorriso, Stunt, Target.
MINARELLI CW50.
YAMAHA BWS, CT50, CR50 Z, Silinder, SPY50, Zuma.

∅ mm	Stroke / Carrera cm ³	N° RINGS						
40,0	49,2 cc	2		2070	86302	2071	2072	88193
46,0	65,0cc	2		2073	86304	2074	11041946	14131246
T6 40,0	49,2 cc	2		5268	86303	5271	11024640	5283
T6 47,6	69,7cc	1		5269	86305	5272	2158	5284









MORINI

5286	CILINDER /ZYLINDER MORINI LC 41.0mm	€ 192,90
2167	CILINDER /ZYLINDER MORINI LC 47.6mm	€ 194,90

REFERENCE

APRILIA Grigio, Haranda, Hot Red, Replica SR, SR 2000R.
ATALA Hacker 50 LC, Skeggia 50 LC.
MORINI AH50L.
SUZUKI AY50LC, Katana LC.

∅ mm	Stroke / Carrera cm ³	N° RINGS						
39,0	49,9 cc	2		5286	86294	85198	85199	85200
45,0	66,5cc	1		2167	86295	85305	2158	2173

CILINDER ZYLINDER CYLINDER

AIRSGAL

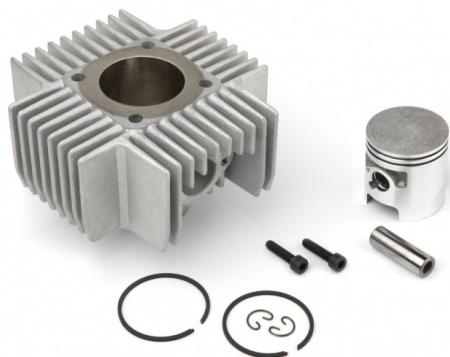













020306435 CILINDER /ZYLINDER MORINI M1 43.5mm 60cc

€ 77,80

REFERENCE

MALAGUTI New Dribbling.
MORINI M1, M101, M1ES 50, M1K.
PUCH Maxi España.
SUZUKI Maxi.

MORINI M1

∅ mm	Stroke / Carrera cm ³	Nº RINGS						
43,0	58,2 cc	2						
			020306435			060306435	110306435	



02020640 CILINDER /ZYLINDER PEUGEOT 103 40.0mm

€ 68,50

2000 CILINDER /ZYLINDER PEUGEOT 103 46.0mm

€ 51,90

2045 CILINDER /ZYLINDER PEUGEOT 103 6P 50cc T6

€ 64,90













85934 CILINDER /ZYLINDER PEUGEOT 103 T6 46.0mm

€ 68,90

REFERENCE

PEUGEOT 103 T3, 104 T3 Brida.

PEUGEOT 103

∅ mm	Stroke / Carrera cm ³	Nº RINGS						
40,0	49,4 cc	2						
			02020640			06020640	11020640	14020640
			2000			2001	2002	85245
T6 40,0	49,4 cc	1	2045			2046	11024640	14020940
T6 46,0	65,3cc	1	85934			85935	88072	85937

CILINDER ZYLINDER CYLINDER

AIRSGAL









- 5291 CILINDER /ZYLINDER PEUGEOT AC T6 40.0mm **T6** € 102,90
- 5292 CILINDER /ZYLINDER PEUGEOT AC T6 47.6mm **T6** € 108,90

REFERENCE

PEUGEOT Buxi SV Geo, Elyseo, Speedaker, Speedfight 2, Trekker, Vivacity, Zenit.

PEUGEOT AC T6

	∅ mm	Stroke / Carrera cm ³	N° RINGS						
T6	40,0	49,2 cc	2	5291	86307	5293	11024640	5297	
T6	47,6	69,7 cc	1	5292	86309	5294	2158	5298	









- 85275 CILINDER /ZYLINDER PEUGEOT FOX 6P 40.0mm € 64,90

REFERENCE

PEUGEOT Fox 50.

PEUGEOT FOX

	∅ mm	Stroke / Carrera cm ³	N° RINGS						
	40,0	49,3 cc	2	85275			06024640	11024640	14024640

CILINDER ZYLINDER CYLINDER

AIRSGAL



2176 CILINDER /ZYLINDER PEUGEOT LC 40.0mm

€ **197,90**







2177 CILINDER /ZYLINDER PEUGEOT LC 47.6mm

€ **205,90**

REFERENCE

PEUGEOT Speedfight 50 LC, X Race.

PEUGEOT LC

∅ mm	Stroke / Carrera cm ³	N° RINGS						
40,0	49,4 cc	1	2176		86296	85703	11024640	2178
47,6	69,5 cc	1	2177		86297	5595	2158	2179



87103 CILINDER /ZYLINDER PEUGEOT LUDIX 40.0mm

€ **85,90**







87567 CILINDER /ZYLINDER PEUGEOT LUDIX T6 47.6mm
T6

€ **142,90**

REFERENCE

PEUGEOT Ludix.

PEUGEOT LUDIX

∅ mm	Stroke / Carrera cm ³	N° RINGS						
40,0	49,2	2		87103		06025040	11025040	87104
T6 47,6	69,7	1		87567		060251476	2158	140251476

CILINDER ZYLINDER CYLINDER

AIRSGAL



88172 CILINDER /ZYLINDER PEUGEOT LUDIX LC 40.0mm

€ **210,90**







88168 CILINDER /ZYLINDER PEUGEOT LUDIX LC 47.6mm

€ **222,90**

REFERENCE

PEUGEOT Ludix Blaster.

PEUGEOT LUDIX LC

∅ mm	Stroke / Carrera cm ³	N° RINGS						
40,0	49,2 cc	2	88172			88173	88174	88175
47,6	69,7 cc	1	88168			88169	2158	88171









02026955 CILINDER /ZYLINDER PEUGEOT SPEEDFIGHT 100cc 55.0mm

€ **297,90**

REFERENCE

PEUGEOT Elyseo 100, Speedfight 100, Vivacy 100, Looxor 100, Trekker 100, x-fight.

PEUGEOT SPEEDFIGHT 100

∅ mm	Stroke / Carrera cm ³	N° RINGS						
55,0	125 cc	2		02026955		06026955	11026955	14026955

CILINDER ZYLINDER CYLINDER

AIRSGAL









2089 CILINDER /ZYLINDER PEUGEOT SV/BUXY 50cc 40.0mm € **75,90**

2090 CILINDER /ZYLINDER PEUGEOT SV/BUXY 65cc 46.0mm € **75,90**

REFERENCE

PEUGEOT Speedfight 50 LC, X Race.

PEUGEOT SV

∅ mm	Stroke / Carrera cm³	N° RINGS						
40,0	49,2 cc	2		2089	86306	2095	2101	87354
46,0	65,0 cc	2		2090	86308	2096	11041946	14022046



2086 CILINDER /ZYLINDER PIAGGIO AC 40.0mm € **74,90**

2081 CILINDER /ZYLINDER PIAGGIO AC 46.0mm € **75,90**

5270 CILINDER /ZYLINDER PIAGGIO AC T6 40.0mm € **102,90**







5287 CILINDER /ZYLINDER PIAGGIO AC T6 46.0mm € **108,90**

REFERENCE

GILERA Easy Moving, Stalker 50, Storm, Typhoon.

PIAGGIO Extrem, Free 50, Liberty, Sfera 50, Stron, Thyphoon, Vespa ET2, Zip.

PIAGGIO AC

∅ mm	Stroke / Carrera cm³	N° RINGS						
40,0	49,2 cc	2		2086	86310	2085	2084	14061340
46,0	65,0cc	2		2081	86312	2082	11041946	14061446
T6 40,0	49,2 cc	2		5270	86311	5275	11024640	5285
T6 47,2	69,7cc	1		5287	86313	5288	2158	5290

CILINDER ZYLINDER CYLINDER

AIRSGAL



2162 CILINDER /ZYLINDER PIAGGIO LC 40.0mm

€ **197,90**







2161 CILINDER /ZYLINDER PIAGGIO LC 47.6mm

€ **199,90**

REFERENCE

APRILIA SR 2005-16.
DERBI GP1.
GILERA Runner 50.
PIAGGIO Extrem, NRG, Zip.

PIAGGIO LC

∅ mm	Stroke / Carrera cm ³	N° RINGS						
40,0	49,2 cc	1	2162		86293	2170	11024640	2174
47,6	69,7 cc	1	2161		85899	2165	2158	2163



020601384

CILINDER /ZYLINDER PIAGGIO VESPINO T6 38.4mm







€ **66,90**

T6

REFERENCE

PIAGGIO VESPA AL, ALX, NLX, Vespino T6.

PIAGGIO VESPINO

∅ mm	Stroke / Carrera cm ³	N° RINGS						
T6 38,4	49,8 cc	2	020601384			060601384	110601384	

CILINDER ZYLINDER CYLINDER

AIRSGAL



01064450







CILINDER /ZYLINDER PIAGGIO ZIP 50.0mm
T6

€ 367,90

**RACING
EXTREME**

REFERENCE
PIAGGIO ZIP.

PIAGGIO ZIP

∅ mm	Stroke / Carrera cm ³	cm ³	Nº RINGS						
T6 50	40	78,2 cc	1	01064450		04064450	06064450		14064450

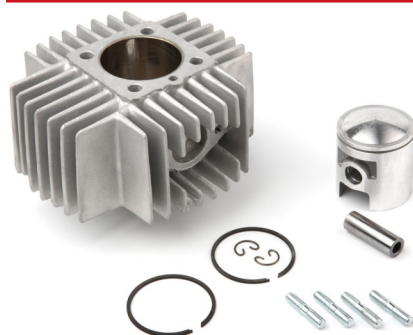

02030138 CILINDER /ZYLINDER PUCH MAXI OM (X20/X30) 38.0mm € 59,90

2010 CILINDER /ZYLINDER PUCH MAXI 44.0mm € 59,90







02030345 CILINDER /ZYLINDER PUCH MAXI OM (X20/X30) 45.0mm € 62,90

02030938 CILINDER /ZYLINDER PUCH MAXI OM (X20/X30) T6 38.0mm € 59,90
T6

REFERENCE

PUCH Automático X20, Maxi Aleta pequeña, X30

PUCH MAXI OT





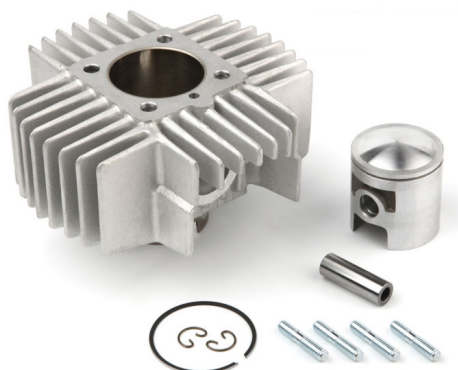

∅ mm	Stroke / Carrera cm ³	cm ³	Nº RINGS						
38,0	48,8 cc		2		02030138		2004	11210138	87076
44,0	65,4cc		2		2010		2011	11210244	87746
45,0	68,4 cc		1		02030345		2064	2080	14030345
T6 38,0	48,8cc		2		02030938		06031138	11210138	87076

CILINDER ZYLINDER CYLINDER

AIRSGAL



PUCH MAXI NT

∅ mm	Stroke / Carrera cm ³	N° RINGS						
38,0	48,8 cc	2	2078			2004	11210138	87076
45,0	68,4 cc	1	2069			2064	2080	14030745
T6 38,0	48,8 cc	2	2076			06031138	11210138	87076





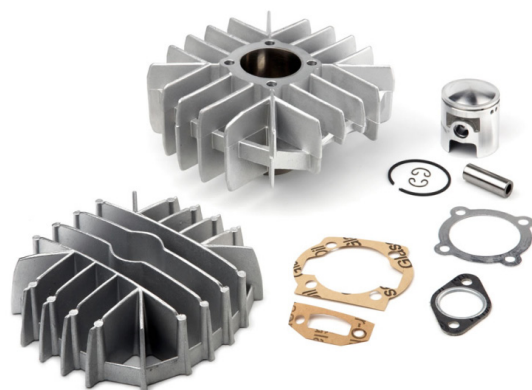

- 2078 CILINDER /ZYLINDER PUCH MAXI NT 50cc STD 38.0mm € 59,90
- 2069 CILINDER /ZYLINDER PUCH MAXI 4T NT 45.0mm € 60,90
- 2076 CILINDER /ZYLINDER PUCH MAXI NT 50cc T6 38.0mm € 59,90

REFERENCE

PUCH Automático Maxi Aleta Grande.



PUCH MAXI

∅ mm	Stroke / Carrera cm ³	N° RINGS						
46,0	63,2 cc	1	87553		04031446	88071	88072	88073
47,0	72,0 cc	1	01030247			06030247	2038	14030247

- 87553 CILINDER /ZYLINDER PUCH MAXI COBRA 46.0mm € 159,90
- 01030247 CILINDER /ZYLINDER PUCH MAXI 47.0mm € 173,90

REFERENCE

PUCH Maxi.

CILINDER ZYLINDER CYLINDER

AIRSGAL









SACHS

012002435 CILINDER / ZYLINDER SACHS 504-505 43.5mm

€ 187,90

REFERENCE

HERCULES
SACHS 504, 505.

mm	Stroke / Carrera	cm ³	N° RINGS						
T6 43,5		62,4 cc	2	012002435		042002435	062002435	112002435	142002435

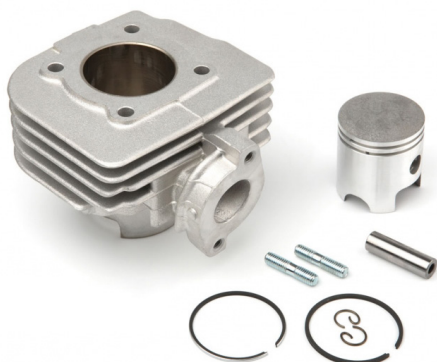

2092 CILINDER / ZYLINDER SUZUKI ADDRESS 50cc 41.0mm

€ 74,90







2091 CILINDER / ZYLINDER SUZUKI ADDRESS 65cc 46.0mm

€ 74,90

REFERENCE

ATALA Byte AT10, EP 50, Hacker AT 12.
DERBI Vamos.
ITALJET Torpedo, Velocifero.
SUZUKI Address 50, AP, AY50, Katana, Sepia, Street Magic.

SUZUKI ADDRESS

mm	Stroke / Carrera	cm ³	N° RINGS						
41,0		49,3 cc	2		2092		2097	2103	87353
46,0		65,0 cc	2		2091		2098	11041946	88014

CILINDER ZYLINDER CYLINDER

AIRSGAL















02052357 CILINDER /ZYLINDER SUZUKI BURGMAN 125cc LC 57.0mm € **207,90**

Available
spring 2017

REFERENCE

SUZUKI Burgman 125 LC ≥ 2007.

SUZUKI BURGMAN

∅ mm	Stroke / Carrera cm ³	N° RINGS						
57,0	124,5 cc	3						
				02052357		06052357		14052357





















88295 CILINDER /ZYLINDER SUZUKI RMX/SMX 41.0mm € **159,90**

86604 CILINDER /ZYLINDER SUZUKI RMX/SMX 48.0mm € **176,90**

REFERENCE

SUZUKI RMX 50.

SUZUKI RMX

∅ mm	Stroke / Carrera cm ³	N° RINGS						
41,0	49,4	2						
				88295		87411	85199	88298
48,0	69,5	2						
				86604		87410	88297	88299

CILINDER ZYLINDER CYLINDER

AIRSGAL

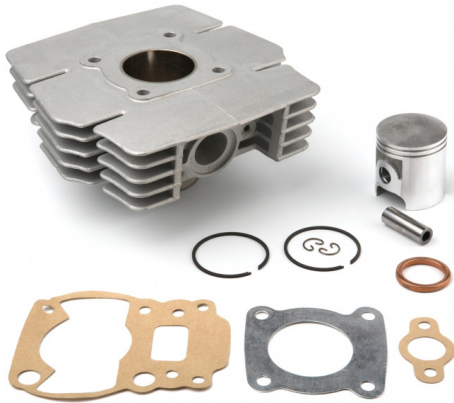







2059 CILINDER /ZYLINDER SUZUKI TSX 70cc 47.0mm

€ **119,90**

REFERENCE

SUZUKI TS 50 X.

SUZUKI TSX

∅ mm	Stroke / Carrera cm ³	N° RINGS						
47,0	68,0 cc	2		2059		2060	2061	88687









02370260 CILINDER /ZYLINDER SYM EURO MX 125cc 60.0mm

€ **119,90**

REFERENCE

PEUGEOT Tweet 125, Vivacity 125, Django.
SYM SYMPHONY 125, VS 125, FIDDLE.

SYM EURO MX

∅ mm	Stroke / Carrera cm ³	N° RINGS						
60,0	163,4 cc	3		02370260		06370260	11370260	14370260

CILINDER ZYLINDER CYLINDER

AIRSGAL









02370342 CILINDER /ZYLINDER SYM MIO 50 4T 42.0mm

€ **119,90**

REFERENCE

SYM MIO 50, Fiddle II, Orbit II, Jet 4, Allo, Symphony.

SYM MIO

∅ mm	Stroke / Carrera cm ³	N° RINGS						
42,0	63,0 cc	3		02370342		06370342	11370342	14370342

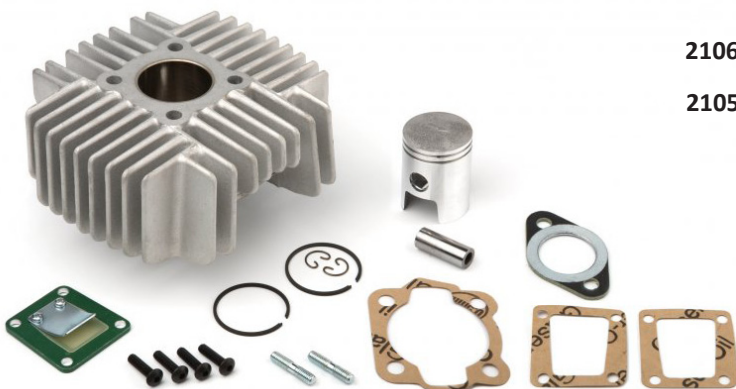

2106 CILINDER /ZYLINDER TOMOS A35 50cc 38.0mm

€ **79,90**







2105 CILINDER /ZYLINDER TOMOS A35 60cc 44.0mm

€ **79,90**

REFERENCE

TOMOS A35 Limited, A35 Quatro, A38B, S25/2 Limited, S25/2 Luxe.

TOMOS A35

∅ mm	Stroke / Carrera cm ³	N° RINGS						
38,0	49,5	2		2106		2107	11210138	14210138
44,0	63,7	2		2105		2108	11210244	5596

CILINDER ZYLINDER CYLINDER

AIRSGAL

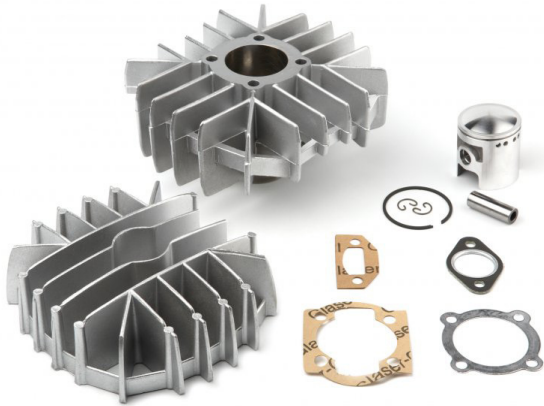







87668 CILINDER /ZYLINDER TOMOS A55 44.0mm € 153,90

REFERENCE

TOMOS A55, Arrow, Revival TS, Streetmate.

TOMOS A55

∅ mm	Stroke / Carrera cm ³	N° RINGS						
44,0	63,7 cc	2	87668			88012	11210244	88075

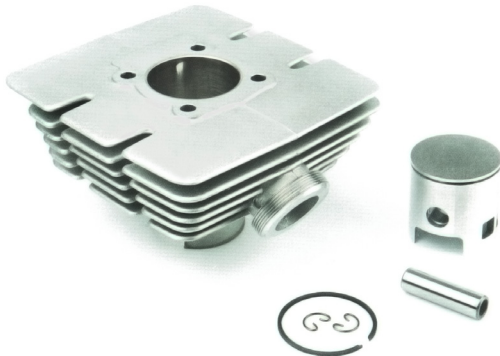







2039 CILINDER /ZYLINDER YAMAHA DTMX 70cc 45.0mm € 79,90

REFERENCE

YAMAHA DT 50, RD 50 (86-97).

YAMAHA DTMX







∅ mm	Stroke / Carrera cm ³	N° RINGS						
45,0	62,4 cc	1		2039		2040	2080	85277

CILINDER ZYLINDER CYLINDER

AIRSGAL



YAMAHA X-MAX 125

∅ mm	Stroke / Carrera cm ³	N° RINGS						
52,0	58,6	124,6 cc	3	02125852				
T6 52,0	58,6	124,6 cc	3	02125952		06125952	11125952	14125952

02125852 CILINDER /ZYLINDER YAMAHA X-MAX 125cc 52.0mm € 164,90







02125952 CILINDER /ZYLINDER YAMAHA X-MAX T6 125cc 52.0mm € 189,90

REFERENCE

MBK Citylinder.
YAMAHA X MAX 125, City 125, WR 125 R, WR 125 X, YZF 125 R, MT 125.



YAMAHA YBR

∅ mm	Stroke / Carrera cm ³	N° RINGS						
54,0	124,0	3	02126854			06126854		
57,4	150,0	3	021270574			061270574		

02126854 CILINDER /ZYLINDER YAMAHA YBR 125cc 54.0mm € 137,90

021270574 CILINDER /ZYLINDER YAMAHA YBR 125cc 57.4mm € 157,90

REFERENCE

YAMAHA YBR 125, 125 CUSTOM, YB 125, XTZ 125.

KRUKAS BURBELWELLE CRANKSHAFT

AIRSAL



31083750 KRUKAS DERBI SENDA <2006 (EURO 2) AIRSAL PRO-R € **299,90**

REFERENCE

DERBI DRD, GPR Racing, R Racer, Senda 50.
GILERA GSM, Zulu

DERBI SENDA <2006

Pin /
Bul. Stroke /
Carrera



12

40

31083750



31085950 KRUKAS DERBI SENDA >2006 (EURO 3) AIRSAL PRO-R € **279,90**

REFERENCE

DERBI SENDA EURO 3, DRD, SM.
ENGINE PIAGGIO.
GILERA RCR, SMT.

DERBI SENDA >2006

Pin /
Bul. Stroke /
Carrera



12

40

31085950

KRUKAS BURBELWELLE CRANKSHAFT

AIRSAL

31134950 KRUKAS MINARELLI AM6 AIRSAL PRO-R

€ 199,90



REFERENCE

APRILIA Alle 50, Extrema, Red rose, RS 50, RX 50.
 MBK X Limit, X Power.
 MINARELLI AM 345/6, AM 6 EU1.
 MOTORHISPANIA Furia 50, Racing RX 50, Supermotard.
 PEUGEOT Supermotard, Trail, XP6, XR6.
 RIEJU MRK, RS1, RR6 50, SMX.
 YAMAHA DT 50 Supermotard, Thunderkit, TZR 50.

MINARELLI AM6

Pin /
Bul. Stroke /
Carrera

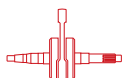

12 39

31134950



31071140 KRUKAS MINARELLI HORIZONTAAL pen10 PRO-R

€ 259,90

* 31073450 KRUKAS MINARELLI HORIZONTAAL pen12 PRO-R

€ 264,90

* 31073350 KRUKAS MINARELLI HORIZONTAAL LC 45 EXTREME

€ 269,90

* ADAPTORKIT
art. 35073450

REFERENCE

APRILIA Area, Gulliver, Ralli LC, Sonic, SR 50, Stealth LC.
 BENELLI 491 Sport Racing, K2 LC.
 BETA ARK LC, Eikon 50.
 ITALJET Dragster.
 MALAGUTI F12, F15, Firefox, Phantom LC.
 MBK Nitro 50.
 RIEJU First 50 LC.
 YAMAHA Aerox 50.

MINARELLI HORIZONTAAL

Pin /
Bul. Stroke /
Carrera

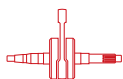

10 39,2

31071140

12 39,2

31073450 * PAGE 23

12 45

31073350 * PAGE 42

KRUKAS BURBELWELLE CRANKSHAFT

AIRSAL



311316476 KRUKAS MINARELLI VERTICAAAL AIRSAL PRO-R € **272,90**

REFERENCE

APRILIA Gulliver, Rally, Scarbeo, Sonic, SR94, SR www.
ATALA Corosello.
BENELLI 491 GT, K2 air, Namur, Pepe.
BETA Ark, Chrono, Tempo, Quadra.
CPI Euro 1, Hussar.
MALAGUTI Centro, Ciak, F10, F12, Phantom 50, Yesterday.
MBK Evolis, Fizz, Flipper, Forte, Hot Champ, Ovetto, Sorriso.
PGO Big Max.
RIEJU First 50, Windi.
YAMAHA Axis, Breeze, Jog 50, Jag Z, Neos, Why, Zest.

MINARELLI VERTICAAAL

Pin /
Bul. Stroke /
Carrera

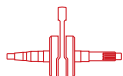

10 **39,2**

311316476



310617476 KRUKAS PIAGGIO SCOOTER AC AIRSAL PRO-R € **199,90**

REFERENCE

GILERA Easy Moving, Stalker 50, Storm, Typhoon.
PIAGGIO Extrem, Free 50, Liberty, Sfera 50, Stron, Thyphoon, Vespa ET2, Zip.

PIAGGIO AC

Pin /
Bul. Stroke /
Carrera



12 **39,3**

310617476

KRUKAS BURBELWELLE CRANKSHAFT

AIRSGAL

35073350 MINARELLI HORIZONTAL LC 45 EXTREME



43,90



* ADAPTORKIT FOR
art. 31073350



ADAPTORKIT

Pin /
Bul. Stroke /
 Carrera



12

45

31073350

AIRSGL

TOEPASSINGLIJST / VERWENDUNGSLISTE

Alle producten in deze folder, inclusief de bijbehorende toepassingslijst, vindt u op onze website: www.mokix.com

Alle Produkte in diesem Prospekt, inklusive der dazugehörigen Zuordnungsliste, finden Sie auf unserer Webseite:
www.mokix.de



www.mokix.com